

2024 NC State 4-H Horse Show

Class 119 Ranch Ground Handling Junior

Show Date: July 13, 2024



Out Gate



9. Walk to brush. Stay stationary and back the horse to the end of the lead. Walk to exit.

8. Trot as shown.

7. Turn 90 left on the forehand (move the hindquarters)

6. Turn 180 right on the hindquarters. Back through rocks.

5. Trot to rocks. Halt.

Judge's Gazebo

2. Walk to center of logs. Send horse in a circle to the left at a walk, crossing each log once.

4. Halt. Set up square for judge.



In Gate

1. Open, walk through, and close gate.

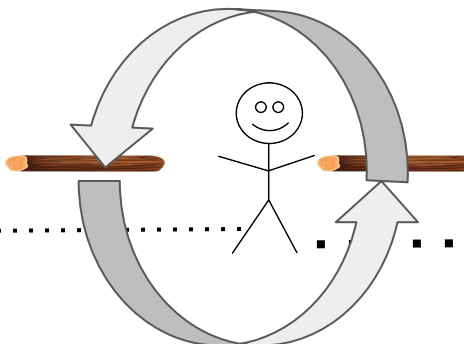

3. Extended walk to judge as shown.

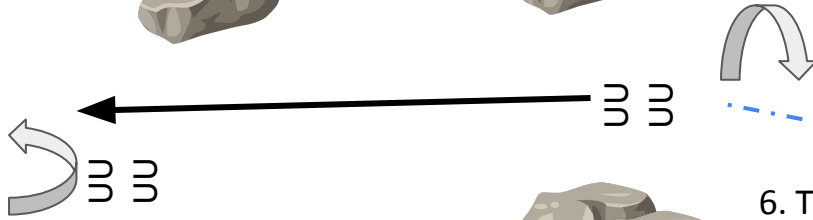
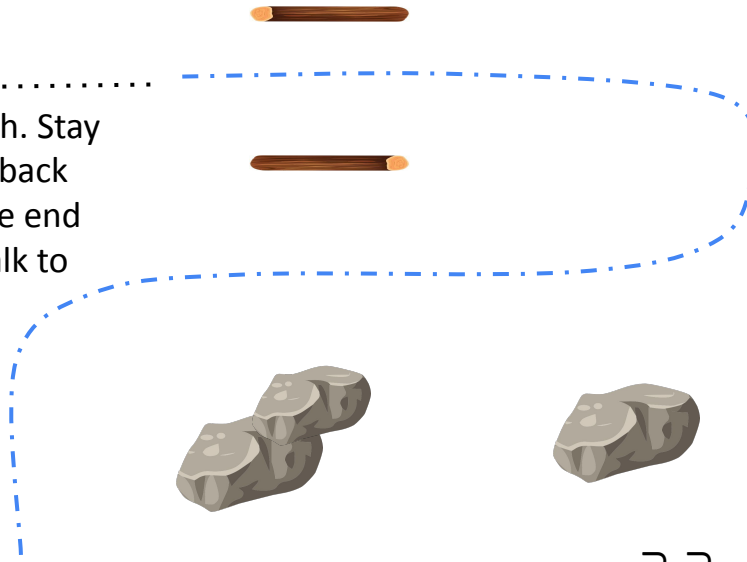

2024 NC State 4-H Horse Show

Class 121 Ranch Trail Junior

Show Date: July 13, 2024



In Gate



1. Walk to standard and remove rope (a rope will be provided or you may hang your own)



2. While carrying rope, trot over logs as shown.

4. When clear of steer, lope left lead as shown.



5. Extended trot through rocks and over log as shown.

3. Halt in rocks. Attempt to rope the steer. Walk to steer and drop rope on or near steer when done, away from horse's legs.

6. Break to a walk and walk over the brush pile (14").



Judge's Gazebo

7. Halt. Sidepass left.



Out Gate



10. Work gate (left hand). Pattern ends when gate is closed.



9. Back through chute as shown. Walk out of chute.

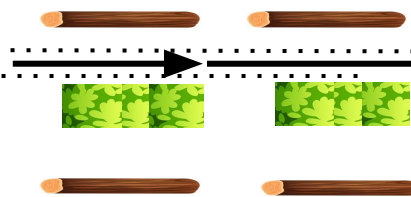

8. Walk over log, bridge, and into chute as shown.



2024 NC State 4-H Horse Show

Ranch Horsemanship (Junior) (Class 140)

Show Date: 07-14-2024

w w w . H o r s e S h o w P a t t e r n s . c o m

w w w . H o r s e S h o w P a t t e r n s . c o m

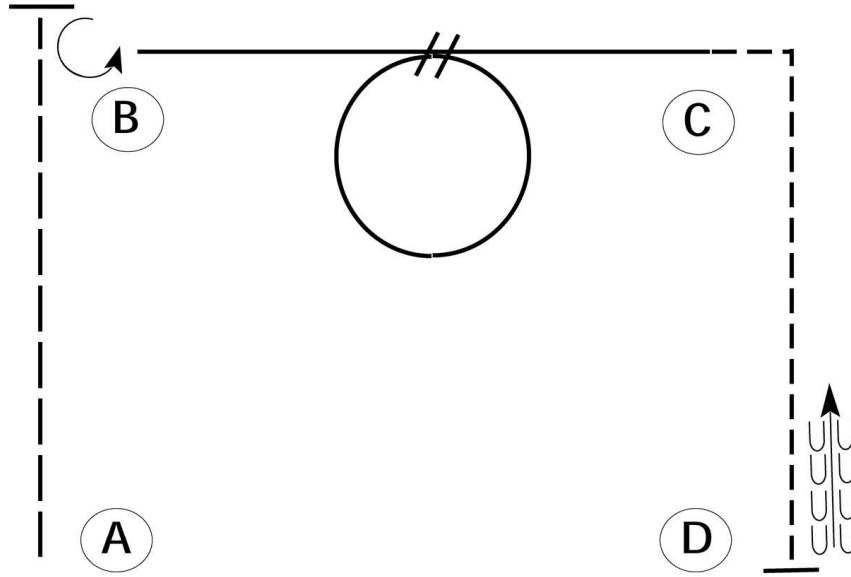

Be ready at A.

1. Extended trot from A past B.
2. Stop past B and perform a 270 degree turn to the left.
3. Lope on the left lead halfway to C.
4. Perform a simple lead change and lope a circle to the right.
5. Continue to lope to C.
6. At C, break to a trot and trot to D.
7. Stop and back approximately one horse length.

Follow the instructions of your ring steward.

Exhibitors perform their pattern to the green cones. ▲

Walk
trot	-----
Extended trot	- - - - -
Lope	—————
Lead Change	//
Back	← U U U U
Marker	(B)

[WH/1-88]

Pattern Provided by:
Show Management

2024 NC State 4-H Horse Show

Ranch Riding JR & SR (Class 141, 142)

Show Date: 07-14-2024

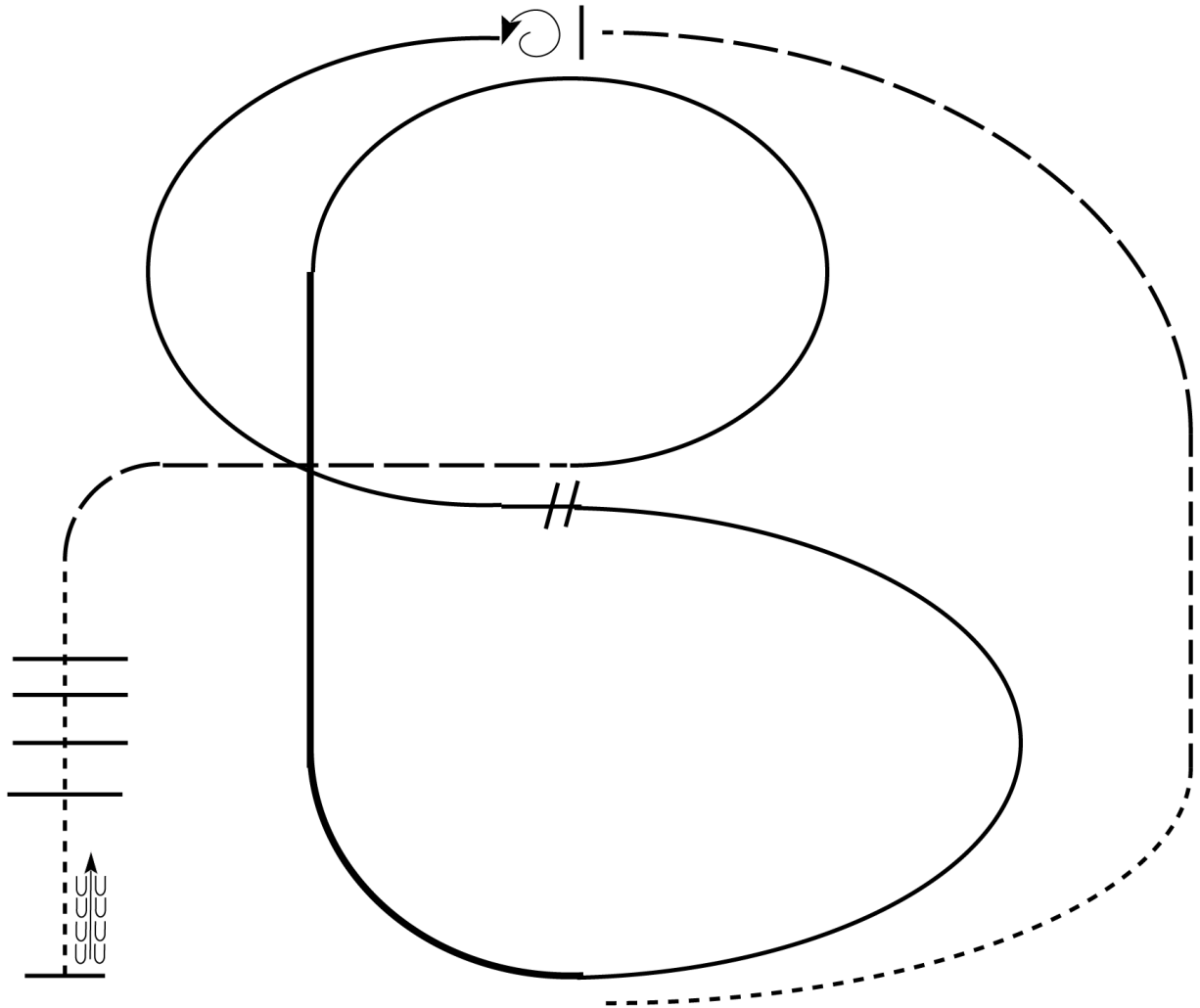

1. Walk
2. Trot
3. Extend the trot, at the top of the arena, stop
4. 360 degree turn to the left
5. Left lead 1/2 circle, lope to the center
6. Change leads (simple or flying)
7. Right lead 1/2 circle
8. Extended lope up the long side of arena (right lead)
9. Collect back to a lope around the top of the arena and back to center
10. Break down to an extended trot
11. Walk over poles.
12. Stop and back

Walk	-----
Jog	- - - - -
Extended Jog	-----
Lope	
Lead Change	///
Back	←←←←←
Marker	(B)

[RR/1]

Pattern Provided by:
Show Management

2024 NC State 4-H Horse Show

Class 143 & 144 Ranch Reining Senior and Junior

Show Date: July 14, 2024

VRH AND RHC RANCH REINING PATTERN 1

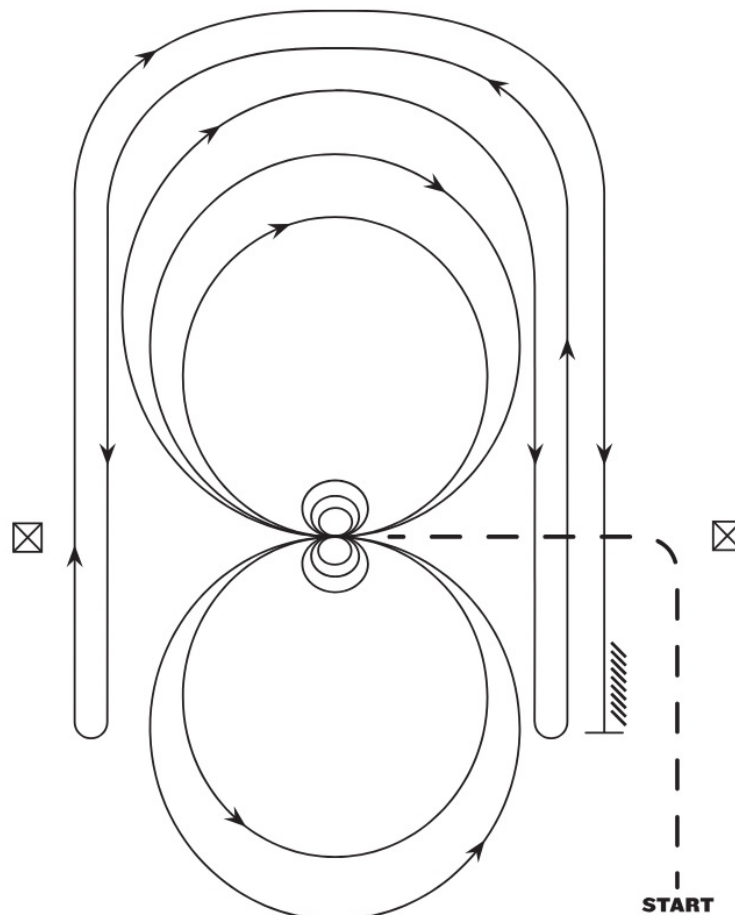

Mandatory Markers along Fence or Wall: The judge shall indicate with markers on arena fence or wall the center of the pattern. Ride pattern as follows: Trot to center of arena and stop.

1. Complete 3 spins in one direction. Hesitate.
2. Complete 3 spins in the opposite direction. Hesitate.
3. Beginning on right lead, complete two large fast circles to the right. Change leads at center of arena.
4. Complete two large fast circles to the left. Change leads at center of arena.
5. Begin a large circle to the right but do not close this circle. Run down the right side of the arena past the center marker and do a left roll back at least 20 feet from the wall or fence, no hesitation.
6. Continue back around the previous circle but do not close this circle. Run down the left side of the arena past the center marker and do a right roll back at least 20 feet from the wall or fence, no hesitation.
7. Continue back around previous circle, but do not close this circle. Run down the right side of the arena past the center marker and do a sliding stop at least 20 feet from the wall or fence. Back up at least 10 feet.

Hesitate to show completion of pattern.

Pattern Provided by:
Show Management